

A sheet of paper of at least 20 cm square would be preferred for this model. Fold and unfold diagonally in half, creasing well.

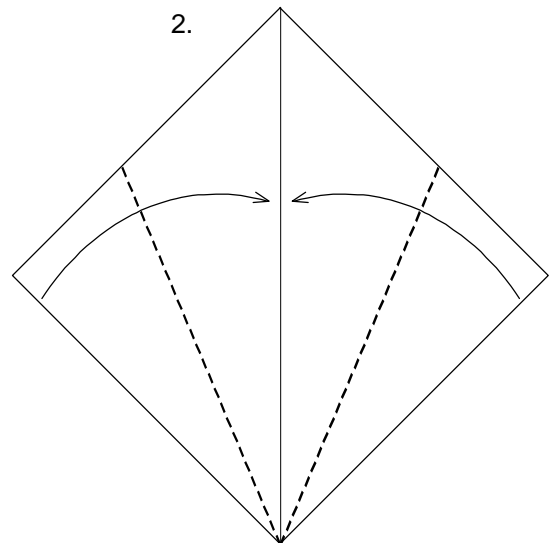

Now fold the lower diagonal edges to meet along the vertical crease line in the centre.

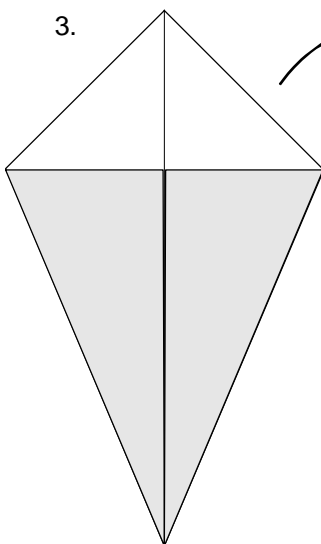

Turn paper over ...

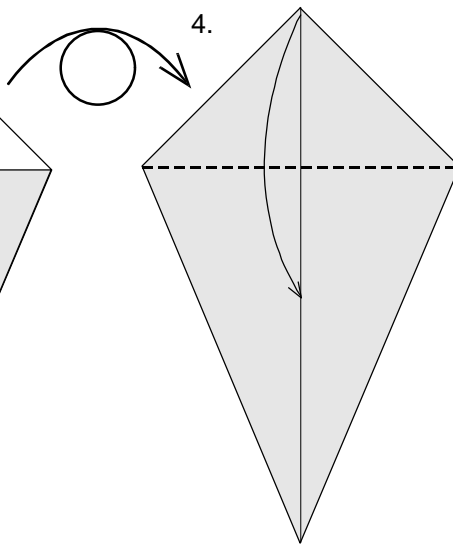

... and fold down the triangular portion at the top as illustrated.

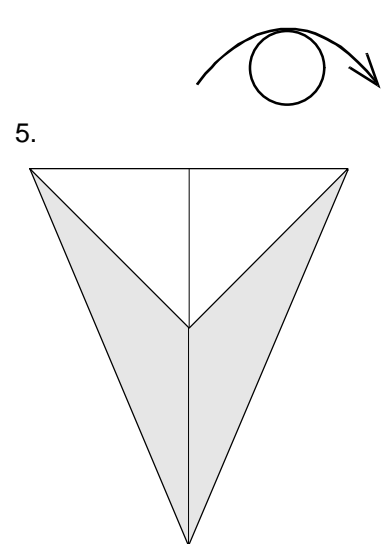

Turn the paper over again ...

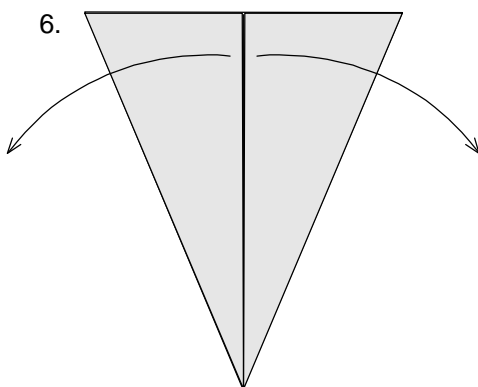

... and unfold the overlapping layer to each side ...

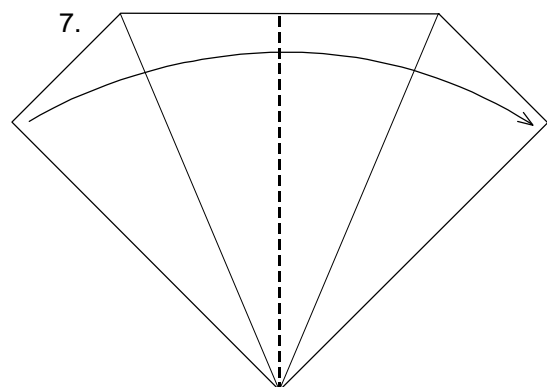

... like this. Now fold vertically in half, from left to right ...

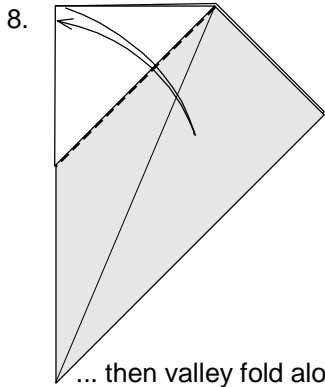

8.

... then valley fold along the edge of the white triangular portion, crease firmly, and unfold.

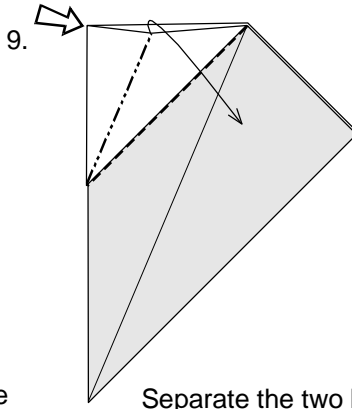

9.

Separate the two layers along the horizontal edge and squash fold.

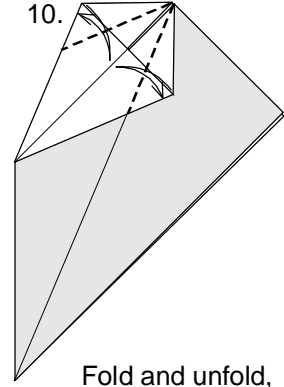

10.

Fold and unfold, Creasing firmly ...

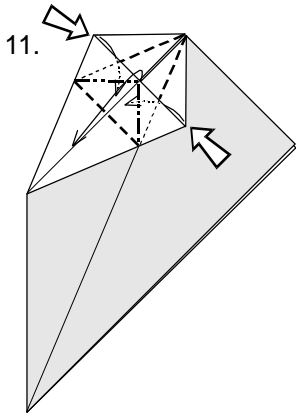

11.

Do a petal fold by pulling the diagonal edge of the uppermost layer 45 degrees down and to the left, while drawing in the horizontal and vertical edges at the top together ...

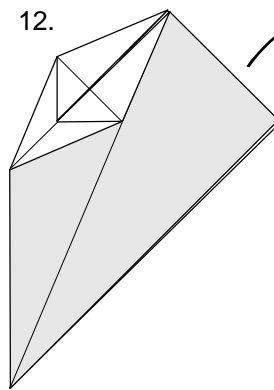

12.

... like this. Turn the paper over, ...

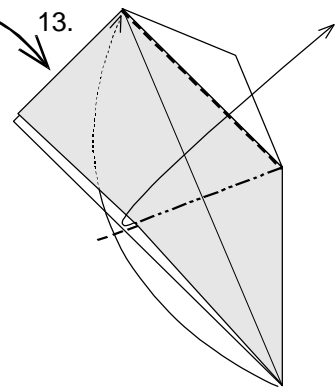

13.

... separate the two layers along the diagonal edges on the left and squash fold.

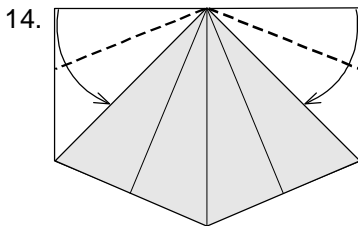

14.

Valley fold the horizontal edge of the white layer to meet the diagonal edge of the coloured layer on each side, ...

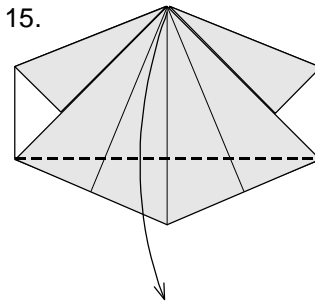

15.

... then fold down the coloured triangular portion in the middle as illustrated.

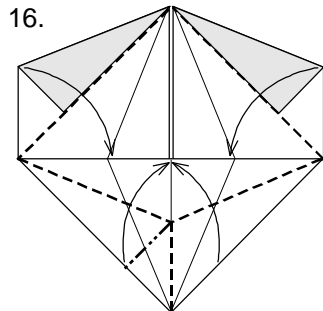

16.

Fold down both corners at the top, and do a rabbit's ear fold at the bottom ...

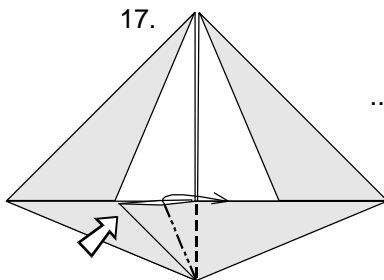

17.

... like this. Separate the two layers of the triangular tab and squash fold, ...

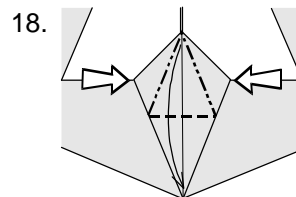

18.

... then mountain fold along the existing diagonal crease lines to narrow the upper section before bringing the point at the top to meet the point at the bottom ...

19.

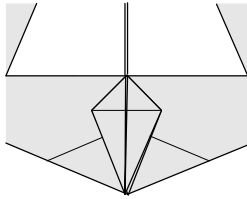

... like this.

20.

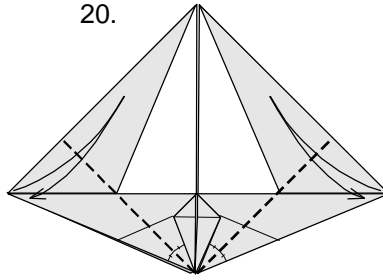

Fold the lower diagonal edges to meet the adjacent diagonal edge of the kite-shaped flap in the centre, crease firmly, and unfold.

21.

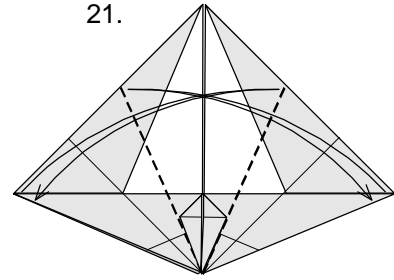

Fold and unfold again as illustrated, creasing firmly again.

22.

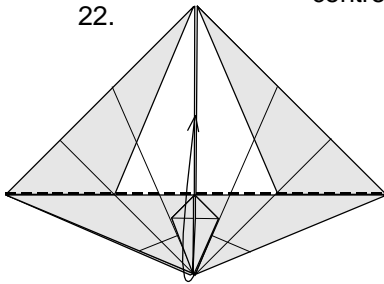

Fold the first layer up,...

23.

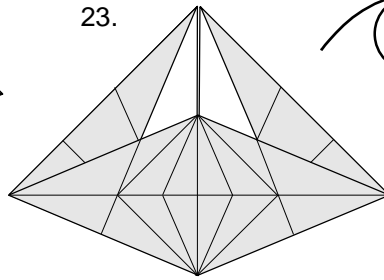

... then turn the model over.

24.

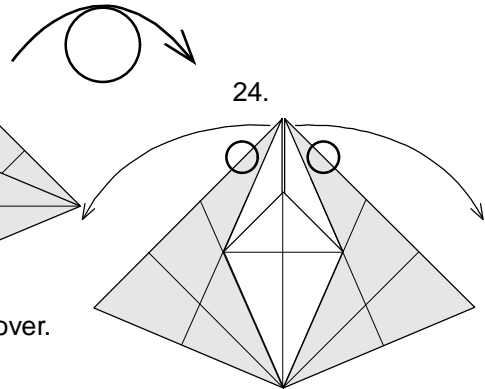

Grasp each side at the circled areas, holding the coloured portions only, then pull apart to open out ...

25.

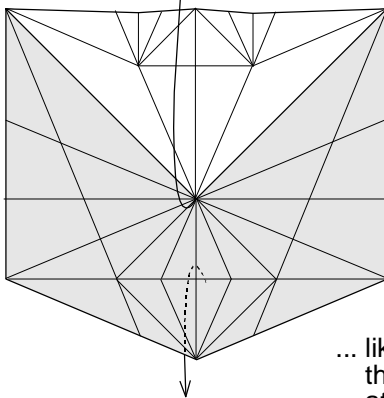

... like this. Now lift up the the white triangular layer at the top and the second layer at the bottom ...

27.

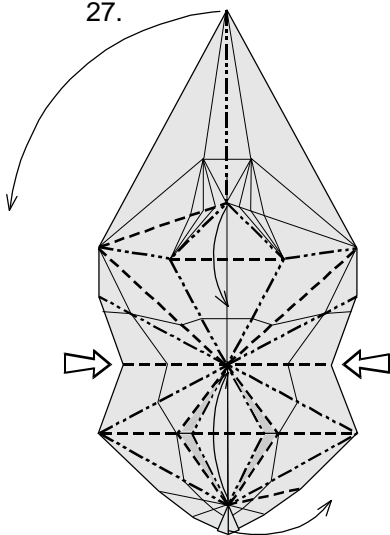

... like this ...

26.

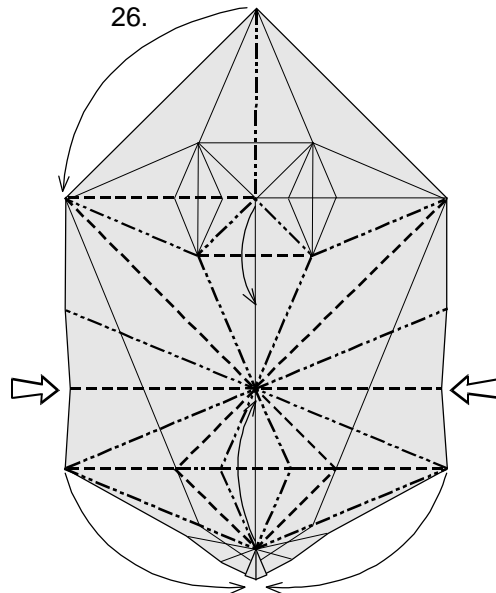

... then collapse along the existing crease lines with mountain and valley folds as illustrated ...

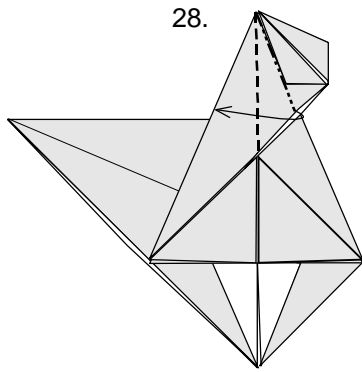

Draw one layer to the left and squash fold ...

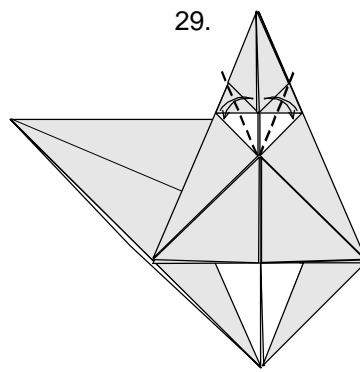

... as illustrated, then fold and unfold, creasing firmly.

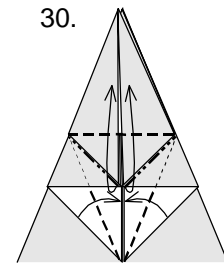

Valley fold the triangular tabs in the middle upwards, at the same time valley folding the lower diagonal edges to meet in the centre ...

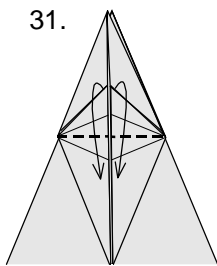

... like this. Fold down the triangular tabs in the middle again.

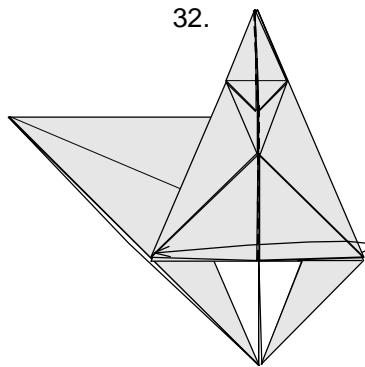

Swivel one layer on the right to the left.

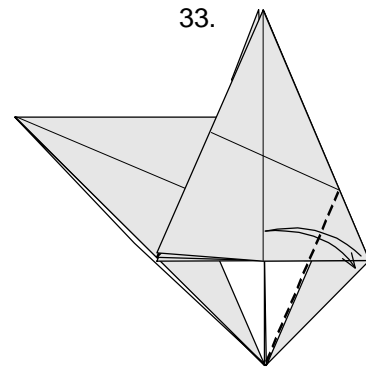

Fold and unfold, creasing firmly, ...

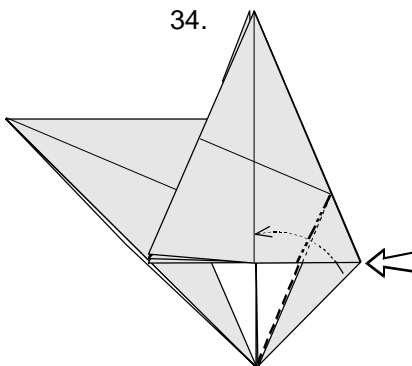

... then reverse fold along the crease lines made in Step 33

...

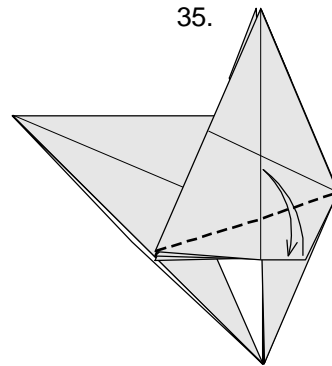

... like so. Fold and unfold, creasing firmly again, ...

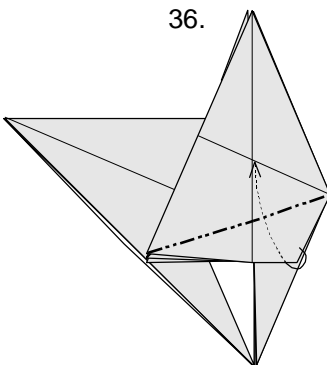

... then mountain fold the excess paper under along the crease line made in Step 35.

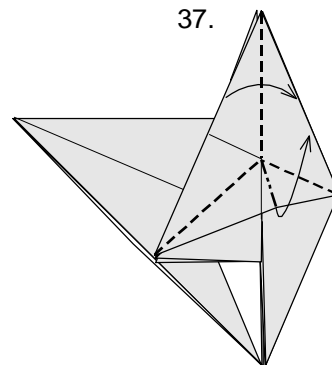

Rabbit's ear fold as shown, swivelling one layer on the left to the right.

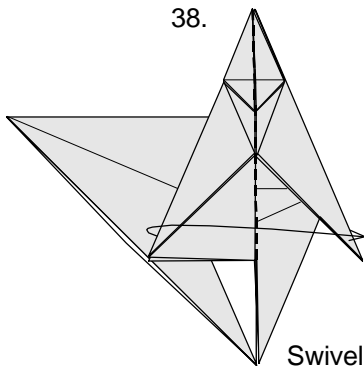

38.

Swivel one layer on the left to the right, and repeat from Step 33 on this side.

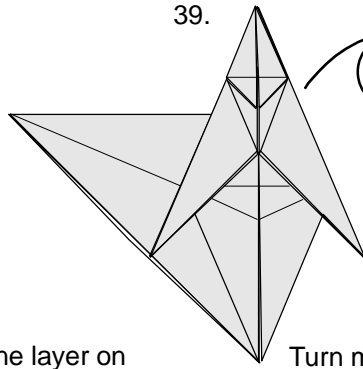

39.

Turn model over.

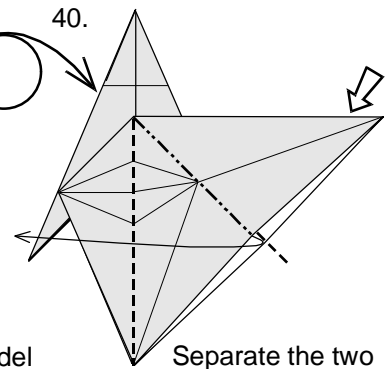

40.

Separate the two layers along the diagonal edges and squash fold, ...

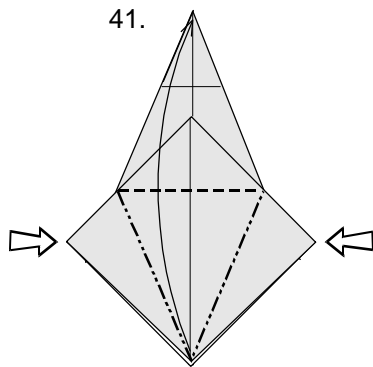

41.

... like this. Reverse fold the corners along the existing crease lines and bring the resulting point at the bottom all the way to the top.

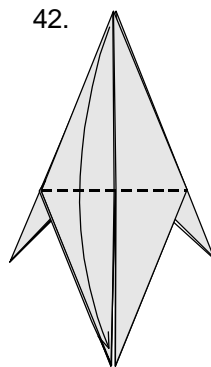

42.

Fold the flap down again ...

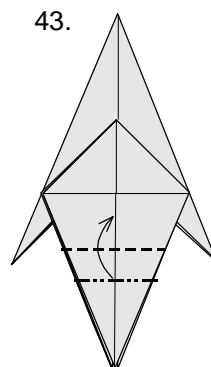

43.

... and crimp with a mountain and valley fold, ...

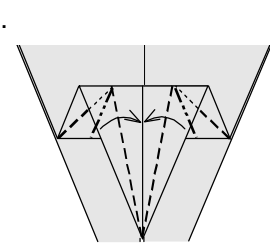

44.

... then narrow as illustrated ...

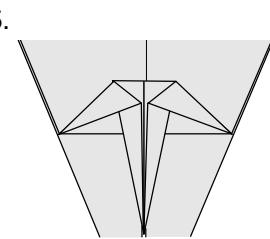

45.

... like this.

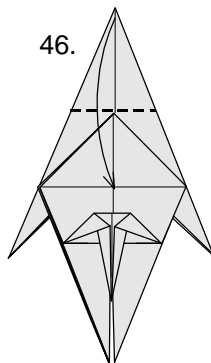

46.

Fold down one layer from the top ...

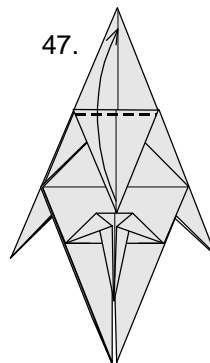

47.

... then fold up again, making a little crimp.

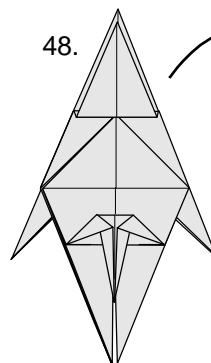

48.

Turn the model over.

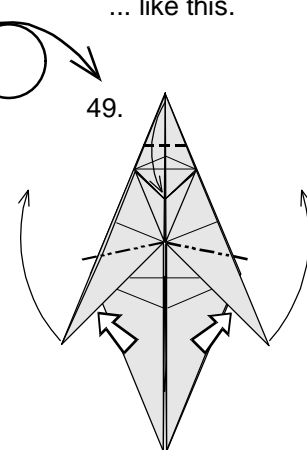

49.

Fold down the first layer at the apex of the model and crease well, then reverse fold the points on each side.

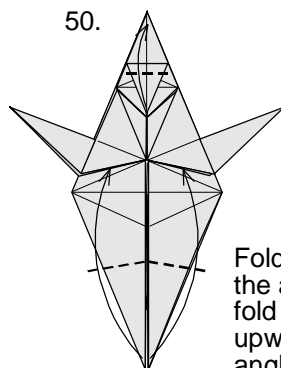

50.

Fold up the the first layer at the apex again, and valley fold the lower points upwards at the illustrated angles and proportions.

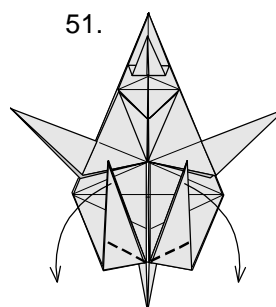

51.

Valley fold the lower points down again.

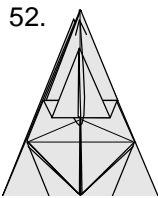

52. Unfold the Steps at 49 and 50 on the apex of the model ...

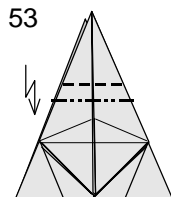

53. ... and refold along the crease lines as illustrated, ...

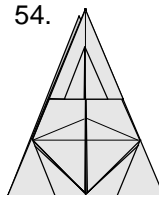

54. ... like this.

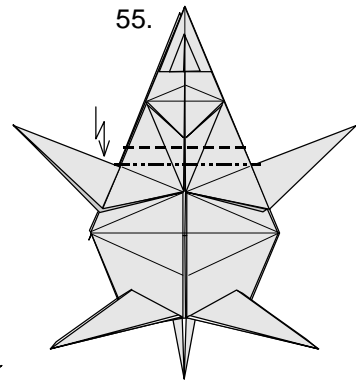

55. Make a crimp as illustrated with a mountain and valley fold, ...

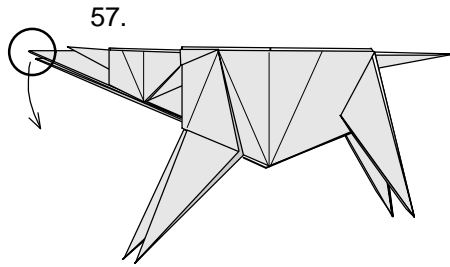

57. Grasp the head firmly and pull down gently ...

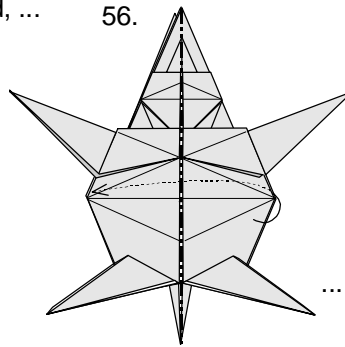

56. ... then mountain fold the model vertically in half.

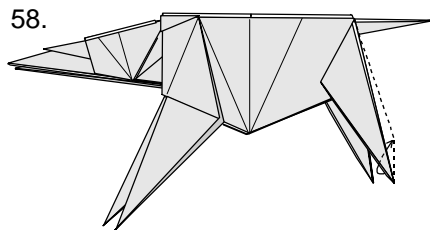

58. Broaden each hind leg by drawing out the second layer to the back as indicated by the dotted lines.

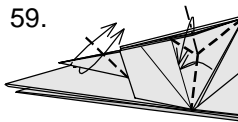

59. Rabbit's ear fold the triangular tabs on each side to form the ears, then flatten the head temporarily and outside reverse fold the short point in the middle to form one horn.

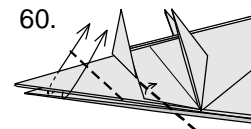

60. Outside reverse fold the next point to form the second horn, and valley fold the little corner on each side to form the eyes.

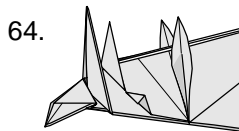

64. ... like this.

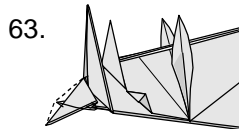

63. ... then lift up the first layer on each side ...

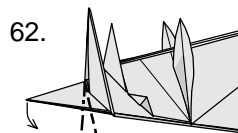

62. Crimp fold the front of the remaining point under ...

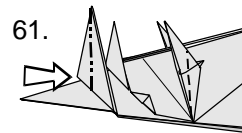

61. Sink the front section of the horn. A pair of tweezers will help. Open out both ears as shown.

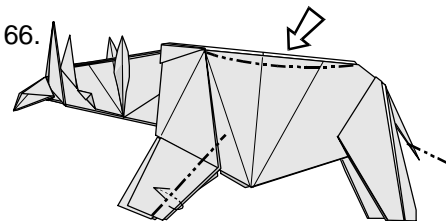

66. Narrow both sides of the forelegs by fold the excess paper within. Do another reverser fold at the tip of the tail, then complete the model by rounding off the back.

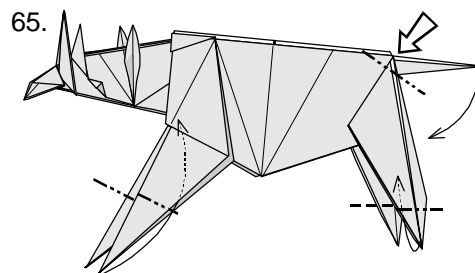

65. Inside reverse fold all the legs and the base of the tail as illustrated.

